



400mA CMOS LDO Regulator

General Description

The CYT6119 is an efficient linear voltage regulator. It has extra low dropout voltage. At light loads the typical dropout voltage is 15mV, at full load the typical dropout voltage is 600mV. The output voltage accuracy is better than 2%.

The CYT6119 has low ground current at 65uA, so it can help prolong battery life. The CYT6119 is specially designed for hand-held, battery -powered devices.

Features

- Typical 175mV dropout voltage at 150mA.
- Guaranteed 400mA output over the full operating temperature range.
- Extremely tight load and line regulation.
- Low temperature coefficient.
- Current and thermal limiting.
- No-load stability.
- Standard SOT-89-3 package.
- RoHS Compliant and 100% Lead (Pb)-Free

Applications

- Active SCSI terminators.
- Post regulators for switching supplies.
- Battery chargers.
- High-efficiency linear power supplies.
- Computer motherboard, display, graphic card DC/DC converter, such as 5V to 3.3V, 3.3V to 2.8V or 3.3V to 2.5V.

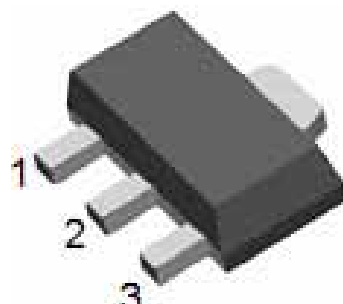

SOT-89 Package



Pin Configuration

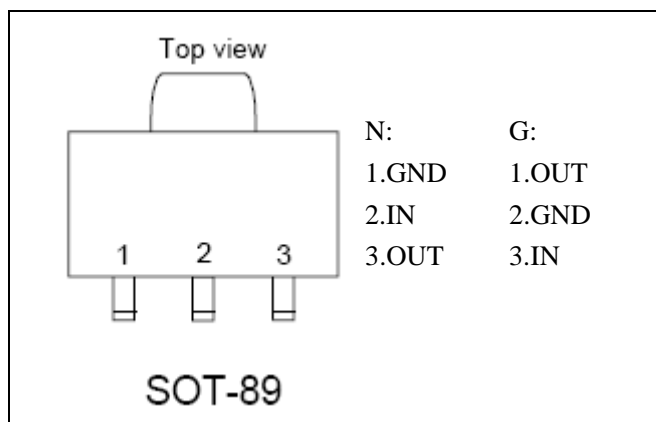

Application Diagram

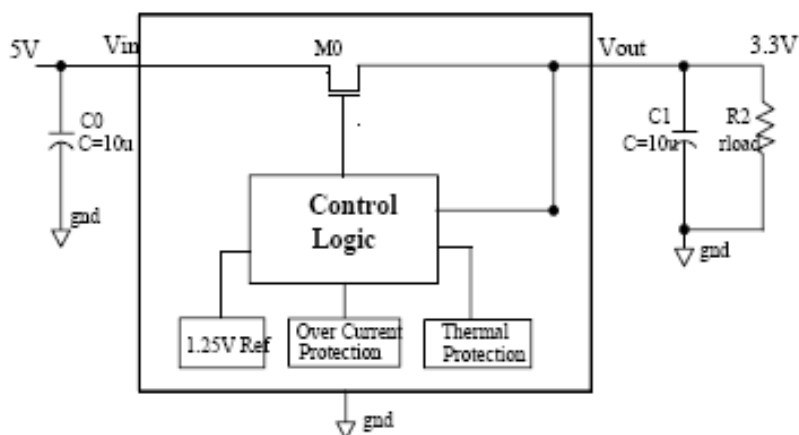

Ordering Information

CYT6119-

PIN (1 3) : 1 G:OUT/GND/IN
 2 N: GND/IN/OUT
 Package Type:1 K: SOT-89-3L

Output Voltage:1 A:Vout=3.3V
 2 B:Vout=2.8V
 3 C:Vout=2.5V
 4 D:Vout=1.8V
 5 E:Vout=1.5V
 6 F: Vout=3.0V



Absolute Maximum Ratings⁽¹⁾

Supply Input Voltage (VIN)	6V
Power Dissipation (PD)	Internally Limited(3)
Junction Temperature (TJ)	0°C to +150°C
Lead Temperature (soldering, 5 sec)	260°C
Storage Temperature (TS)	-10°C to +150°C

Operating Ratings⁽²⁾

Package Thermal Resistance	180°C /W
Supply Input Voltage (VIN)	+2.8V to +5.5V
Junction Temperature (TJ)	0°C to +125°C

Electrical Characteristics

VIN = VOUT + 1.0V; COUT = 4.7μF, IOUT = 10mA; TJ = 25°C; unless otherwise specified.

Symbol	Parameter	Conditions	Min	Typ	Max	Units
VOUT	Output Voltage Accuracy	CYT6119-1.5V	1.470	1.5	1.530	V
		CYT6119-1.8V	1.764	1.8	1.836	
		CYT6119-2.5V	2.450	2.5	2.550	
		CYT6119-2.8V	2.744	2.8	2.856	
		CYT6119-3.3V	3.234	3.3	3.366	
VOUT/ T	Output Voltage Temperature Coefficient	Note4	--	50	--	ppm/
VOUT/VOUT	Line Regulation	VIN=VOUT+1V to 5.5V	--	1	--	%
VOUT/VOUT	Load Regulation ⁽⁵⁾	IOUT=10mA to 250mA ⁽⁵⁾	--	1	--	%
		IOUT=10mA to 400mA ⁽⁵⁾	--	1.5	--	
VIN-VOUT	Dropout Voltage ⁽⁶⁾	IOUT=10mA	--	15	--	mV
		IOUT=150mA	--	175	--	
		IOUT=250mA	--	320	--	
		IOUT=400mA	--	600	--	mV
T _{PROTECTION}	Thermal Protection	Thermal Protection Temperature	--	150	--	
		Protection Hysterisys	--	20	--	
PSRR	Ripple Rejection	F=120Hz	--	51	--	dB
I _{GROUND}	Ground Current	IOUT=10mA	--	65	--	uA
		IOUT=400mA	--	110	--	
I _{LIMIT}	Current Limit	VOUT=0V	--	600	--	mA

Note 1: Exceeding the absolute maximum rating may damage the device.

Note 2: The device is not guaranteed to function outside its operating rating.



CYT 6119

- Note 3:** The maximum allowable power dissipation at any TA (ambient temperature) is calculated using: $PD(MAX) = (TJ(MAX) - TA)/\theta JA$. Exceeding the maximum allowable power dissipation will result in excessive die temperature, and the regulator will go into thermal shutdown. See Table 1 and the “Thermal Considerations” section for details.
- Note 4:** Output voltage temperature coefficient is the worst-case voltage change divided by the total temperature range.
- Note 5:** Regulation is measured at constant junction temperature using low duty cycle pulse testing. Parts are tested for load regulation in the load range from 100 μ A to 500mA. Changes in output voltage due to heating effects are covered by the thermal regulation specification.
- Note 6:** Dropout voltage is defined as the input to output differential at which the output voltage drops 2% below its nominal value measured at 1V differential.

Application Hints

Like any Low dropout regulator, CYT6119 requires external capacitors to ensure stability. The external capacitors must be carefully selected to ensure the performances.

Input Capacitor:

An Input Capacitor of at least 10 μ F is required. Ceramic or Tantalum can be used. The value can be increased without upper limit.

Output Capacitor:

An Output Capacitor is required for look stability. It must be located no more than 1cm away from the VOUT pin, and connected directly between VOUT and GND pins. The minimum value is 10 μ F but once again its value can be increased without limit.

Thermal Consideration

It is important that the thermal limit of the package should not be exceeded. The CYT6119 has built-in thermal protection. When the thermal limit is exceeded, the IC will enter protection, and the VOUT will be reset to zero. The power dissipation for a given application can be calculated as follows: The Power Dissipation (PD) is

$$PD = I_{OUT} * [V_{IN} - V_{OUT}]$$

The thermal limit of the package is then limited to $PD(MAX) = [TJ - TA]/\theta JA$ where TJ is the junction temperature, TA is ambient temperature, and θJA is around 180 $^{\circ}$ C/W for CYT6119. CYT6119 is designed to enter thermal protection at 150 $^{\circ}$ C. For example, if TA is 25 $^{\circ}$ C then the max PD is limited to about 0.7W. In other words, if $I_{OUT}(MAX) = 400mA$, then $[V_{IN} - V_{OUT}]$ can not exceed 1.75V.



Typical Performance Characteristics

(VIN = 5V, CIN = 1μF, COUT = 10μF, TA=25°C, unless otherwise noted.)

Load Regulation

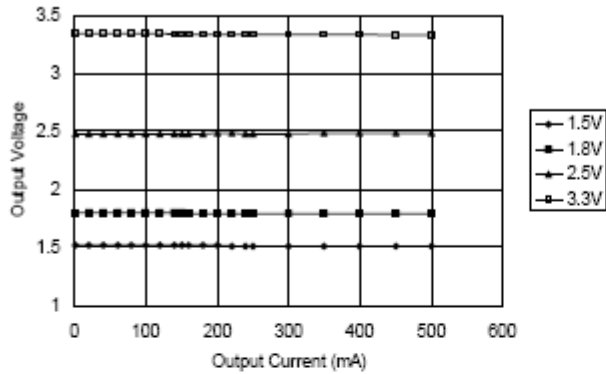

Output Voltage vs Temperature

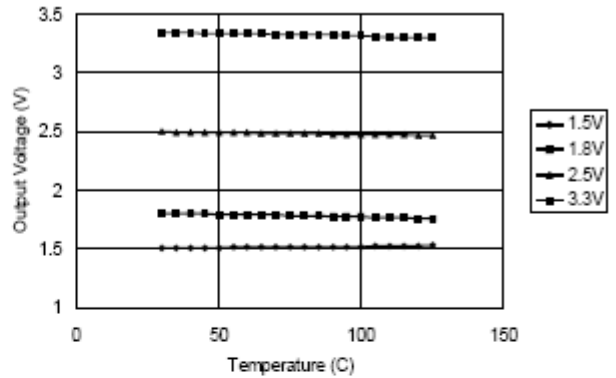

Quiescent Current vs Temperature (Output Voltage @ 2.5V)

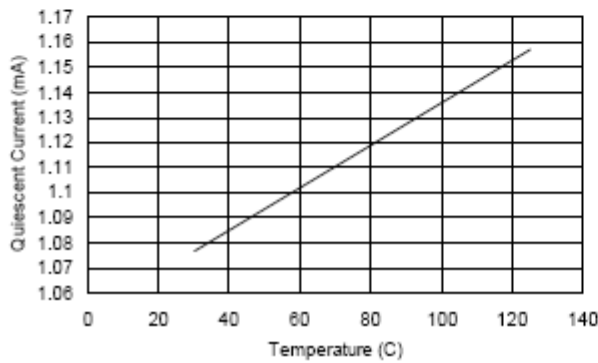

Dropout Voltage vs Output Current

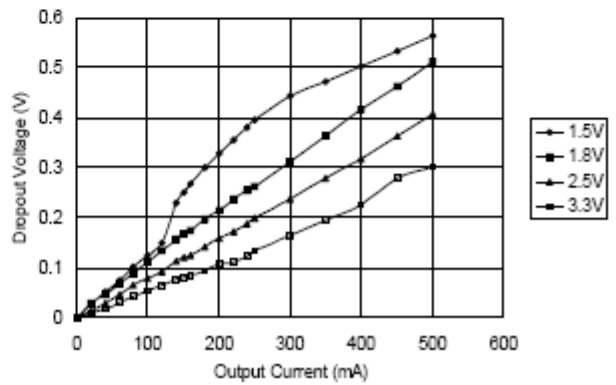

Line Transient

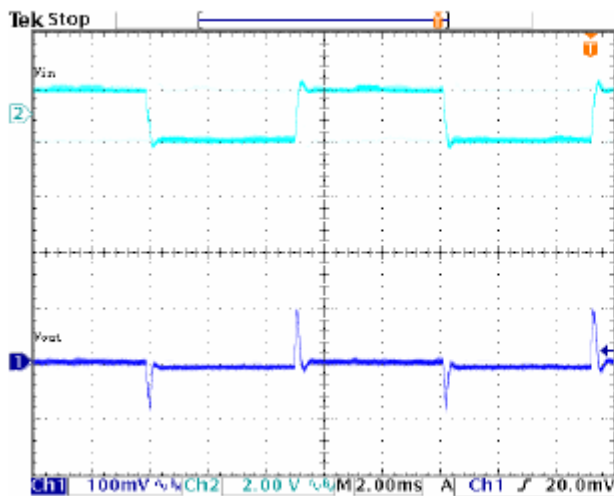

Load Transient (10mA – 500mA)

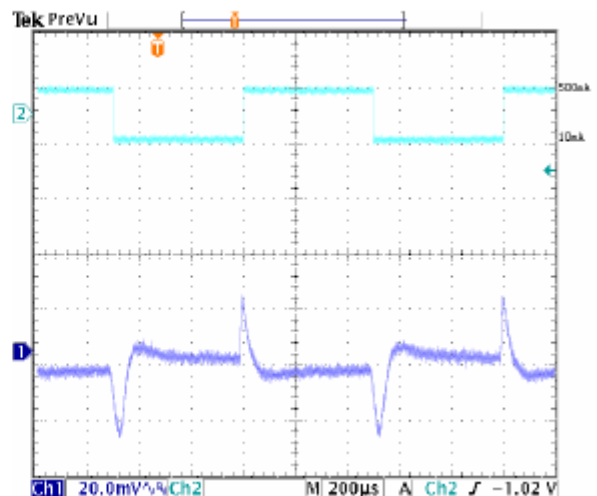



Outline Drawing for SOT-89

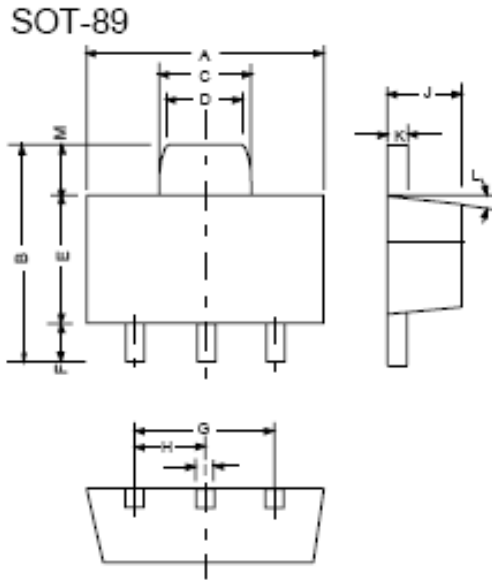

DIMENSIONS				
DIM ^N	INCHES		MM	
	MIN	MAX	MIN	MAX
A	0.173	0.181	4.400	4.600
B	0.159	0.167	4.050	4.250
C	0.067	0.075	1.700	1.900
D	0.051	0.059	1.300	1.500
E	0.094	0.102	2.400	2.600
F	0.035	0.047	0.890	1.200
G	0.118REF		3.00REF	
H	0.059REF		1.50REF	
I	0.016	0.020	0.400	0.520
J	0.055	0.063	1.400	1.600
K	0.014	0.016	0.350	0.410
L	10 ° TYP		10 ° TYP	
M	0.028REF		0.70REF	