



Product Approval Sheet 产品承认书			
Product 产品类别		SMD 0.3W 9V High Voltage 2835 LED (Warm white)	
Part Number 产品型号		CYT2835-009W-1030-8-E	
The version number 版本号		A/1	
Customer Specification 客户规格			
Customer Name 客户名称			
CCT(K)/WD(nm) 色温 (K) /波长 (nm)		2800-3200K	
Color Bin 色区		/	
(lm) / (mcd) 光通量 (lm) /亮度 (mcd)		26-31lm	
CRI 显色指数		80-85	
SDCM 色容差		/	
Vf (v) 正向电压		9-10V	
If (mA) 正向电流		30mA	
Remarks 备注			
SUPPLIER/供应商确认栏		CUSTOMER/客户确认栏	
Prepared/Date 制作	Approved/Date 批准	R&D Dept/Date 研发/工程	Approved/Date 批准
徐平亮			



Product Number Explanation 产品编号说明

CYT XXXX-XXX X-XXXX -X-XXX

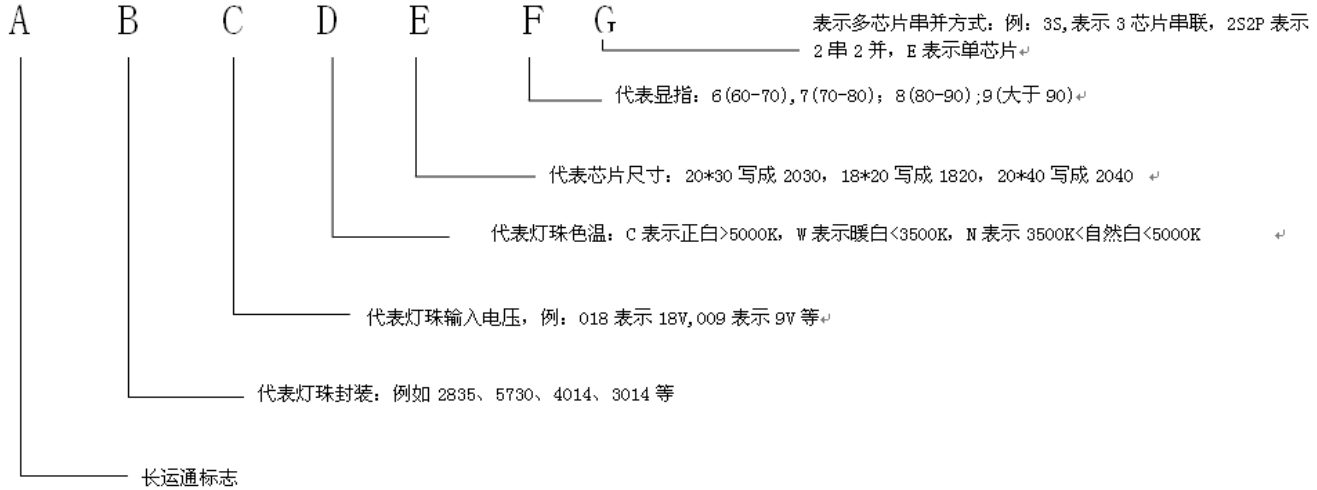

A:代表长运通品牌

(On behalf of CYT brand)

B: 代表灯珠封装: 例如 2835、5730、4014、3014 等

(On behalf of the package size: such as 2835, 5730, 4014, 3014 etc)

C: 代表灯珠输入电压, 例: 018 表示 18V, 009 表示 9V 等

(On behalf of the input voltage, example: 018 as 18V, 009 as 9V, etc)

D: 代表灯珠色温: C 表示正白 >5000K, W 表示暖白 <3500K, N 表示 3500K < 自然白 <5000K

(On behalf of the color temperature: C as cool white > 5000K, W as warm white < 3500K, N as natural white < 5000K)

E: 代表芯片尺寸: 20*30 写成 2030, 18*20 写成 1820, 20*40 写成 2040

(On behalf of the chip size, example: 20*30 as 2030, 18* 20 as 1820, 20*40 as 2040)

F: 代表显指: 6(60-70),7(70-80); 8(80-90);9(大于 90)

(On behalf of the CRI: 6 as 60-70, 7 as 70-80; 8 as 80-90; 9 as >90)

G: 表示多芯片串并方式: 例: 3S,表示 3 芯片串联, 2S2P 表示 2 串 2 并, E 表示单芯片

(On behalf of the multi-chip series parallels mode, example: 3S as 3 chips in series, 2S2P as 2 series 2 parallels , E as single chip)

SMD 0.6W 18V High Voltage 2835 Series Data Sheet

● Features

- 1 . 3.5*2.8*0.7mm standard package.
- 2 . Emitted Color: Cool White.
- 3 . Wide viewing angle.
- 4 . Suitable for all SMT assembly methods.
- 5 . High luminous intensity output.
- 6 . Pb-free.
- 7 . RoHS compliant.
- 8 . ERP compliant.



● Applications

- 1 . General lighting
- 2 . Indicators
- 3 . Illumination

● Package Dimensions

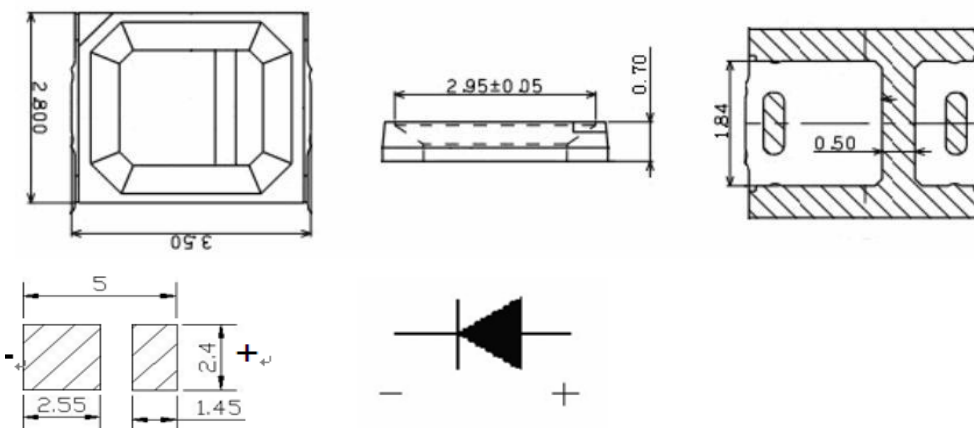

Notes:

1. All dimensions are in millimeter.
2. Tolerance is ± 0.1 mm unless otherwise noted.



ATTENTION
OBSERVE PRECAUTIONS
FOR HANDLING
ELECTROSTATIC
SENSITIVE DEVICES



● Absolute maximum ratings at Ta=25°C

Parameter	Symbol	Absolute Maximum Rating	Unit
Forward Current	If	30	mA
Pulse Forward Current	Ifp	100	mA
Reverse Voltage	VR	15	V
Power Dissipation	PD	300	mW
Operating Temperature	Totg	-30~+85	°C
Storage Temperature	Tstg	-40~+100	°C
Junction Temperature	Tj	115	°C
Solder Temperature	Ts	Reflow Soldering : 260°C for 10sec . Hand Soldering : 300°C for 3 sec .	

Note: Ifp conditions with pulse width ≤10ms and duty cycle ≤10%

● Electro-Optical Characteristics (TSoldering=25°C)

Parameter	Symbol	Value			Unit	Condition
		Min.	Typ.	Max.		
Forward Voltage	VF	9	9.5	10	V	If=30mA
Luminous Flux	Φ	26	--	31	LM	
Color Temperature	CCT	2800	--	3200	K	
Color Rendering Index	Ra	80	--	85	--	
Thermal resistance	Rth		33		°C/W	
Dominant wavelength	DW	--	--	--	Nm	
Viewing angle	201/2	--	120	--	Deg	
Reverse Current	IR	--	--	10	uA	VR=30V

Notes: Tolerance of Luminous Flux 10% ;

Tolerance of Forward Voltage (VF) ±0.1V ;

Tolerance of Wavelength (X,Y) ±0.01 (CCT±5%) ;

Tolerance of Color Rndering Index (CRI) ±2 ;

Tolerance of Dominant wavelength ±1 ;



● Typical Optical-Electrical Characteristics curves (Environment Parameter : Temperature=25°C , Humidity=45%)

Forward Current VS Forward Volatage ↵

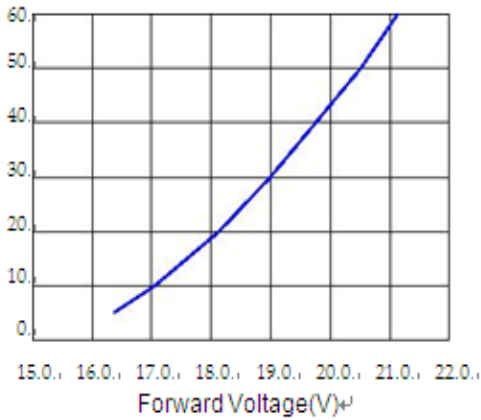

Relative Flux VS Forward Current ↵

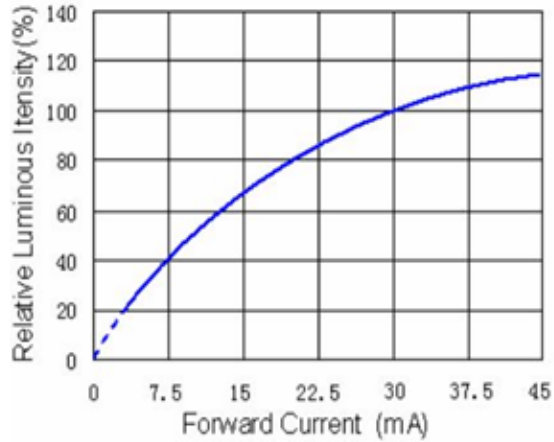

Relative Flux VS Ambient Temperature ↵

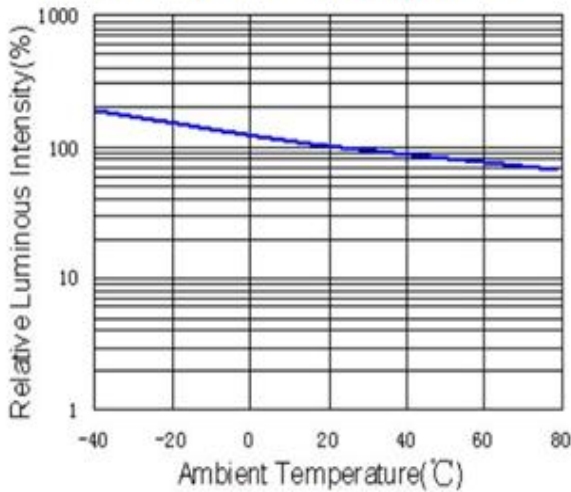

Forward Current VS Ambient Temperature ↵

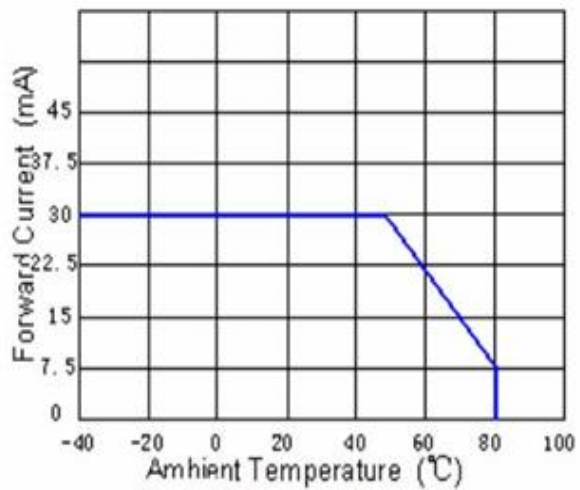

Relative Spectral Distribution ↵

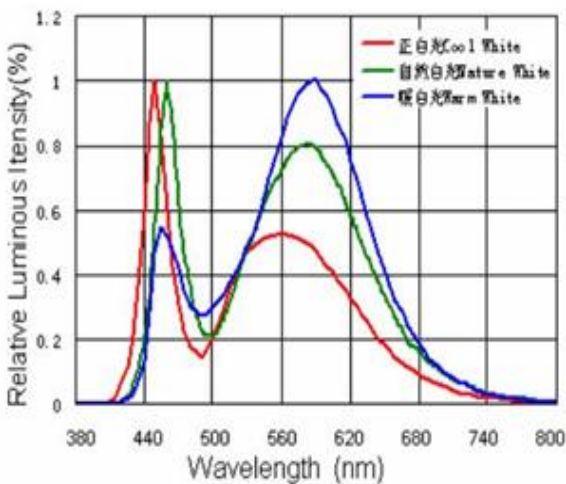

Typical Spectral Distribution ↵

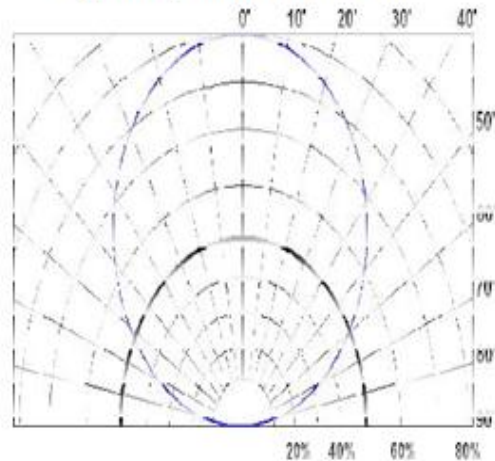

● The C.I.E. 1931 Chromatic Diagram

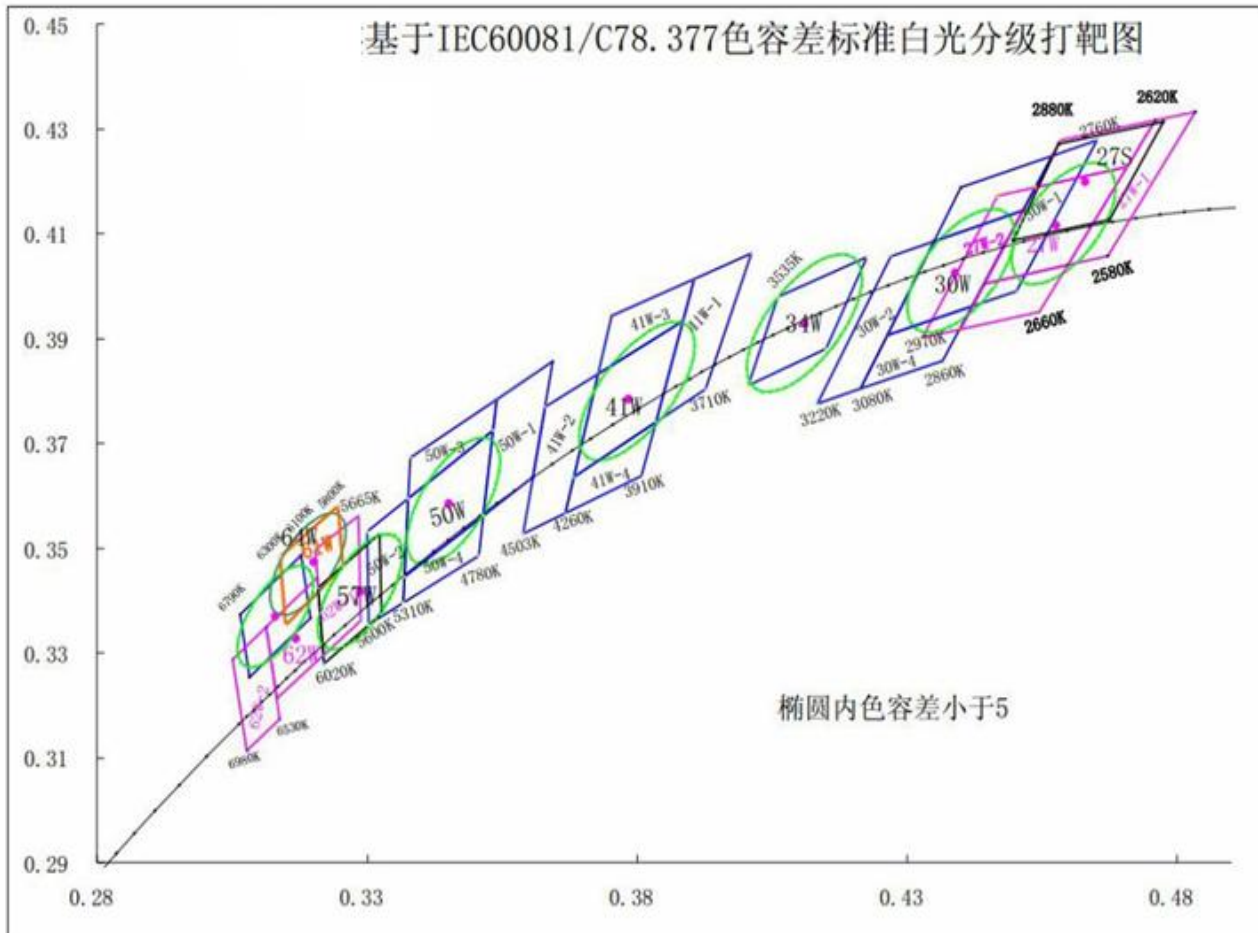

● Bin Range of Chromatic Coordinates

BIN Code	CCT	CIE-X	CIE-Y	BIN Code	CCT	CIE-X	CIE-Y
27W	2660-2860K	0.4444	0.4005	27W-3	2660-2860K	0.4538	0.4189
		0.4538	0.4189			0.4584	0.4279
		0.4708	0.4228			0.4760	0.4317
		0.4598	0.4041			0.4708	0.4228
27W-1	2580-2660K	0.4598	0.4041	27W-4	2660-2860K	0.4399	0.3918
		0.4760	0.4317			0.4444	0.4005
		0.4834	0.4333			0.4598	0.4041
		0.4672	0.4058			0.4545	0.3951
27W-2	2860-2970K	0.4329	0.3902	27S	2620-2880K	0.4497	0.4088
		0.4468	0.4173			0.4581	0.4272
		0.4538	0.4189			0.4775	0.4314
		0.4399	0.3918			0.4675	0.4127

BIN Code	CCT	CIE-X	CIE-Y	BIN Code	CCT	CIE-X	CIE-Y
30W	2860-3080K	0.4264	0.3907	30W -3	2860-3080K	0.4350	0.4086
		0.4350	0.4086			0.4400	0.4189
		0.4515	0.4145			0.4569	0.4249
		0.4420	0.3962			0.4515	0.4145
30W -1	2760-2860K	0.4420	0.3962	30W -4	2860-3080K	0.4214	0.3805
		0.4569	0.4249			0.4264	0.3907
		0.4652	0.4279			0.4420	0.3962
		0.4503	0.3991			0.4366	0.3858
30W -2	3080-3220K	0.4134	0.3776	34W	3265-3535K	0.4006	0.3811
		0.4270	0.4057			0.4061	0.3980
		0.4350	0.4086			0.4226	0.4056
		0.4214	0.3805			0.4150	0.3881
41W	3910-4260K	0.3683	0.3636	41W -3	3910-4260K	0.3728	0.3833
		0.3728	0.3833			0.3753	0.3944
		0.3885	0.3934			0.3906	0.4014
		0.3835	0.3741			0.3885	0.3934
41W -1	3710-3910K	0.3835	0.3741	41W -4	3910-4260K	0.3667	0.3567
		0.3906	0.4014			0.3683	0.3636
		0.4012	0.4063			0.3835	0.3741
		0.3927	0.3804			0.3808	0.3638
41W -2	4260-4503K	0.3589	0.3528				
		0.3630	0.3770				
		0.3728	0.3833				
		0.3667	0.3567				
50W	4780-5310K	0.3369	0.3446	50W -3	4780-5310K	0.3376	0.3595
		0.3376	0.3595			0.3380	0.3673
		0.3533	0.3725			0.3540	0.3784
		0.3515	0.3562			0.3533	0.3725
50W -1	4503-4780K	0.3515	0.3562	50W -4	4780-5310K	0.3367	0.3396
		0.3540	0.3784			0.3369	0.3446
		0.3644	0.3857			0.3515	0.3562
		0.3607	0.3636			0.3507	0.3486
50W -2	5310-5600K	0.3303	0.3355	57W	5500-6020K	0.3220	0.3280
		0.3300	0.3532			0.3209	0.3425
		0.3376	0.3595			0.3323	0.3528
		0.3367	0.3396			0.3327	0.3375



BIN Code	CCT	CIE-X	CIE-Y	BIN Code	CCT	CIE-X	CIE-Y
62W	6020-6530K	0.3133	0.3214	62W -3	6020-6530K	0.3113	0.3350
		0.3113	0.3350			0.3103	0.3418
		0.3208	0.3444			0.3204	0.3498
		0.3219	0.3296			0.3208	0.3444
62W -1	5665-6020K	0.3219	0.3296	62W -4	6020-6530K	0.3138	0.3174
		0.3204	0.3498			0.3133	0.3214
		0.3284	0.3562			0.3219	0.3296
		0.3288	0.3362			0.3221	0.3255
62W -2	6530-6980K	0.3077	0.3114				
		0.3051	0.3288				
		0.3113	0.3350				
		0.3138	0.3174				
61W	5800-6300K	0.3149	0.3353	61W-3	5800-6300K	0.3139	0.3484
		0.3139	0.3484			0.3137	0.3522
		0.3246	0.3581			0.3243	0.3619
		0.3255	0.3466			0.3246	0.3581
61W-1	5600-5800K	0.3255	0.3466	61W-4	5800-6300K	0.3152	0.3312
		0.3243	0.3619			0.3149	0.3353
		0.3299	0.3671			0.3255	0.3466
		0.3310	0.3525			0.3258	0.3425
61W-2	6300-6760K	0.3082	0.3254				
		0.3060	0.3411				
		0.3139	0.3484				
		0.3152	0.3312				
64W	6100-6790K	0.3082	0.3254	64W -3	6100-6790K	0.3065	0.3374
		0.3065	0.3374			0.3060	0.3411
		0.3178	0.3487			0.3173	0.3524
		0.3195	0.3367			0.3178	0.3487
64W -1	5880-6100K	0.3195	0.3367	64W -4	6100-6790K	0.3087	0.3217
		0.3173	0.3524			0.3082	0.3254
		0.3217	0.3568			0.3195	0.3367
		0.3239	0.3411			0.3200	0.3330
64W -2	6790-7100K	0.3043	0.3173				
		0.3021	0.3330				
		0.3065	0.3374				
		0.3087	0.3217				



● **Bin Range of Forward Voltage**

Bin Code	Voltage range (V)	Condition	Bin Code	Voltage range (V)	Condition
1	8.0-8.5	If=30mA	6	10.5-11.0	If=30mA
2	8.5-9.0		7		
3	9.0-9.5		8		
4	9.5-10.0		9		
5	10.0-10.5		10		

Note: Tolerance of Forward Voltage (VF) $\pm 0.1V$

● **Bin Range of Luminous Flux**

Bin Code	Luminous Flux range(lm)	Condition
P	20-25	If=30mA
Q	25-30	
R	30-35	
S	35-40	

Note: Tolerance of Luminous flux: $\pm 10\%$.



● Reliability Test

Test Item	Test Conditions	Continuous cycle	Result	Reference Standard
Temperature Cycling	-40°C 30min ↑↓25°C(5min) 100°C 30min	100 cycle	0/22	JESD22-A104
Thermal Shock	-40°C 30min ↑↓ 100°C 30min	100 cycle	0/22	JESD22-A106
High Temperature Storage	Ta=100°C	1000 hours	0/22	JESD22-A103
Low Temperature Storage	Ta=-40°C	1000 hours	0/22	JESD22-A119
Operation Life	Ta=25°C IF=30mA	1000 hours	0/22	JESD22-A108
High Humidity HeatLife Test	60°C RH=85% IF=30mA	1000 hours	0/22	JESD22-A101
Solder Resistance	260°C(Max.), within 10seconds. (Max.)	3 times	0/22	JESD22-B106

● Judgment criteria of failure for the reliability

Item	Symbol	Condition	Judgment criteria for failure	
Forward voltage	VF	IF=30mA		USL×1.1
Reverse current	IR	VR=30V		10uA
Luminous Flux	Φ	IF=30mA	LSL×0.7	



● Packaging Specifications

Dimensions of Tape (Unit: mm)

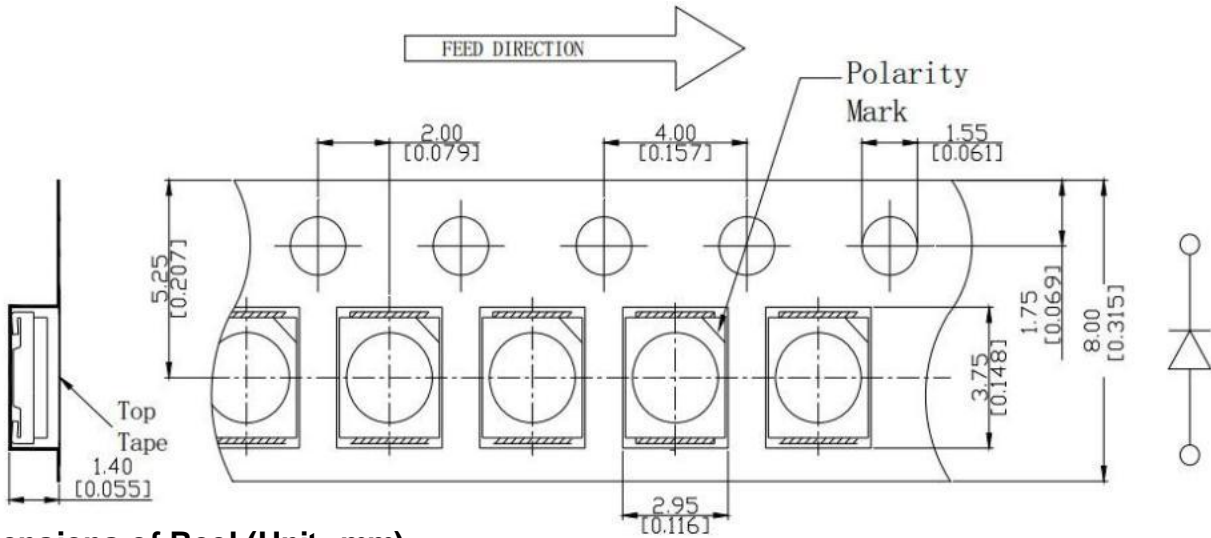

Dimensions of Reel (Unit: mm)

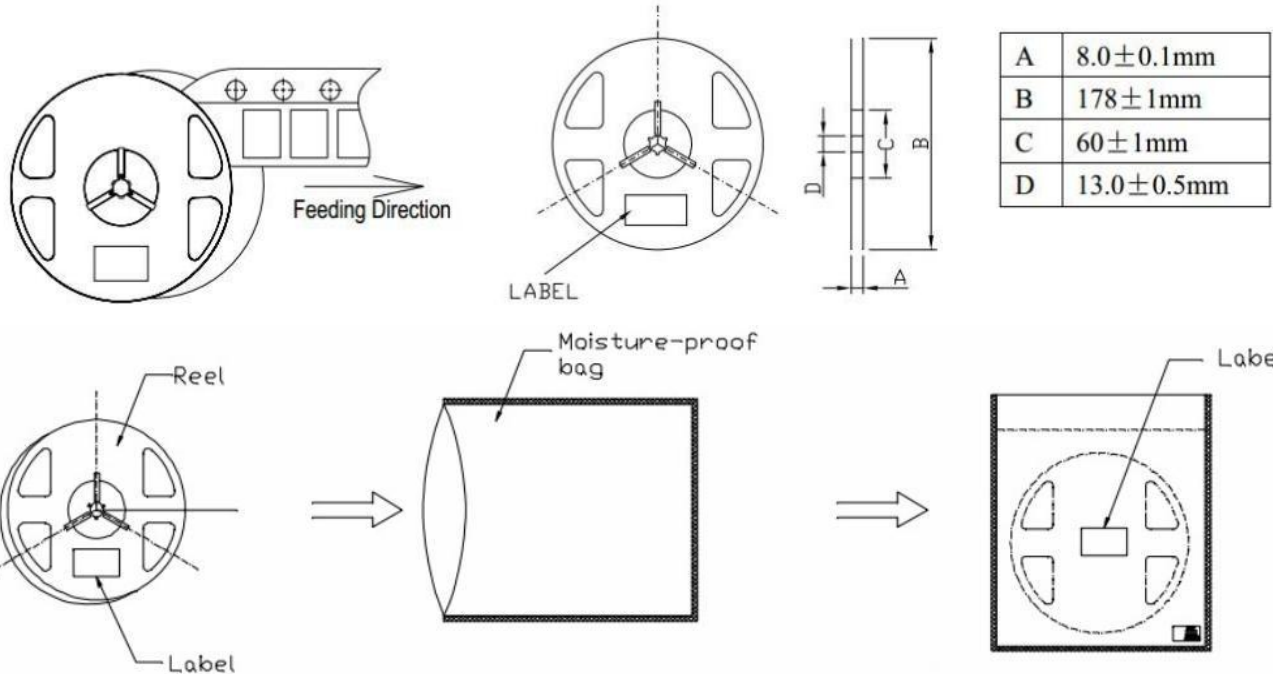

NOTES :

1. Tolerance unless mentioned is $\pm 0.1\text{mm}$; Unit = mm ;
2. The maximum number of missing lamps is two;
3. The cathode is oriented towards the tape sprocket hole in accordance with ANS/EIA RS-481 specifications.
4. 4,500 pcs/ Reel.

● **Reflow profile**

Soldering condition

● **Recommended soldering conditions**

Reflow		Soldering	
Pre-heat	160 ~ 180°C	Temperature	300°C Max 3 second Max (one time only)
Pre-heat time	120 seconds Max.		
Peak temperature	260°C Max.		
Soldering time	10 seconds Max.		
Condition	Refer to Temperature-profile		
		Soldering time	

● **After reflow soldering rapid cooling should be avoided**

Pb-free solder temperature profile

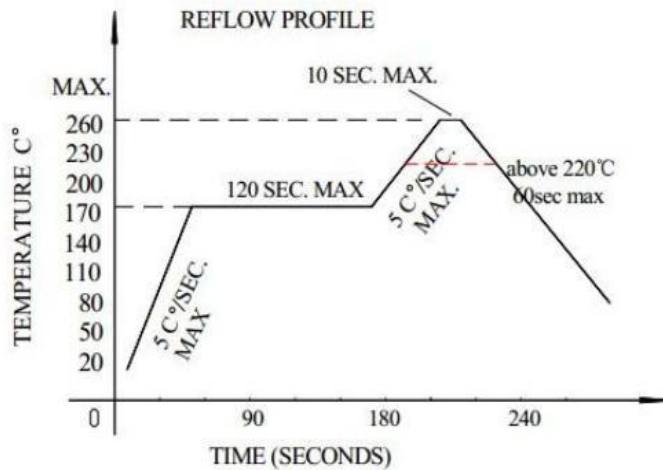

1. We suggest that the reflow soldering temperature is $240 \pm 5^\circ\text{C}$, the highest control the welding temperature to 260°C ;
2. Reflow soldering should not be done more than two times ;
3. When soldering ,do not put stress on the LEDs during heating ;

Soldering iron

1. When hand soldering, keep the temperature of the iron under 300°C , and at that temperature keep the time under 3 sec ;
2. The hand soldering should be done only a time ;
3. The basic spec is ≤ 5 sec. when the temperature of 260°C , do not contact the resin when hand soldering ;

Rework

1. Customer must finish rework within 5 sec under 260°C ;
2. The head of iron can not touch the resin ;
3. Twin-head type is preferred ;

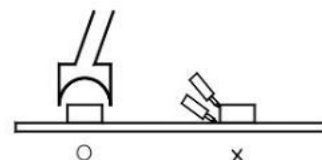



● CAUTIONS

Storage

1. Storage condition before opening the package: 5°C~30°C, the largest percentage relative humidity is 60% and the storage period is one month. The LEDs beyond the storage period just can be used after dealing as step 4.
2. After opening the package, If the LEDs will be Infrared reflow soldering, Oxygen phase reflow soldering or any other welding.
 - a. must be welding within 24 hours.
 - b. the storage humidity must be below 30%.
3. If the situation does not satisfy 2a or 2b, the LEDs must be roasted.
4. If the LEDs need to be roasted, the roast temperature should be 60°C +/-3 and the roast time should be 48 hours.

ESD

Static Electricity or power surge will damage the LED.

The following procedures may decrease the possibility of ESD damage:

1. All production machinery and test instruments must be electrically grounded.
2. Use a conductive wrist band or anti-electrostatic glove when handling these LEDs.
3. Maintain a humidity level of 50% or higher in production areas.
4. Use anti-static packaging for transport and storage.

Cleaning

1. Led should be cleaned in a normal temperature and the time for cleaning should be less than 3 minutes ; please use Alcohol as cleaner ,before you use other cleaning solvent ,please make sure that the cleaner will not make any damage to the LED performance or the appearance .
2. Ultrasonic Cleaning is also commonly used for cleaning LED , please verify the Ultrasonic cleaning 's Power and time to avoid any damage to the LED .

The recommended solvent for cleaning

Common cleaning solvent 常用清洁溶剂	Disable cleaning solvent 禁用清洁溶剂
Alcohol酒精	Thinner、Acetone、Two fluorine resin、 Acetone b dilute 稀释剂、丙酮、二氟脂、三氯乙稀

Handling Precautions

Compare to epoxy encapsulant that is hard and brittle,silicone is softer and flexible.Although its characteristic significantly reduces thermal stress,it is more susceptible to damage by external mechanical force.

As a result,special handling precautions need to be observed during assembly using silicone encapsulated LED products.Failure to comply might leads to damage and premature failure of the LED.

1. Handle the component along the side surfaces by using forceps or appropriate tools

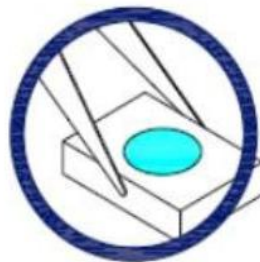



2. Do not directly touch or handle the silicone lens surface. It may damage the internal circuitry.



3. Do not stack together assembled PCBs containing exposed LEDs. Outside impact may scratch the silicone lens or damage the internal circuitry.



4. During surface-mounting, the pickup capillary diameter should be larger than the silicone lens to insure the capillary does not scratch or damage the lens.

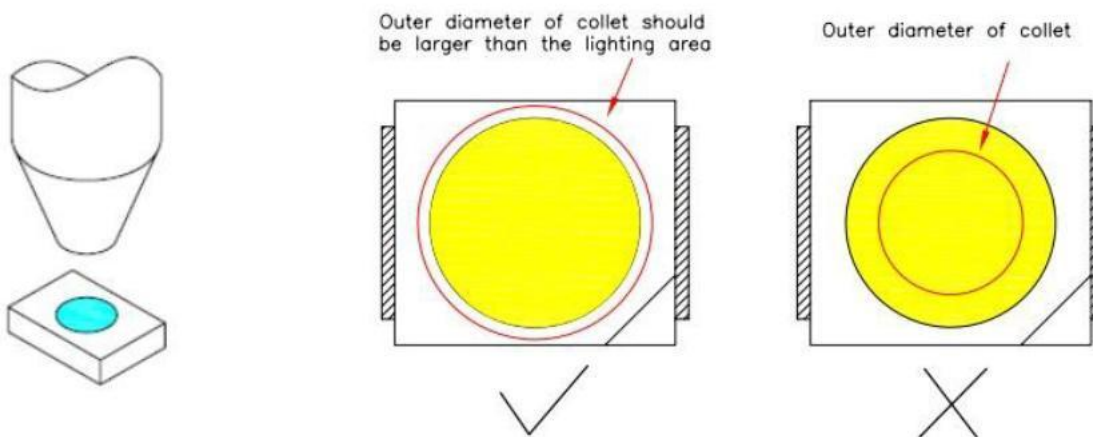

5. LED operating environment and sulfur element composition cannot be over 100PPM in the LED mating usage material. (LED工作环境及与 LED适配的材料中硫元素及化合物成份不可超过 100PPM)

6. When we need to use external glue for LED application products, please make sure that the external glue matches the LED packaging glue. Additionally, as most of LED packaging glue is silica gel, and it has strong Oxygen permeability as well as strong moisture permeability; in order to prevent external material from getting into the inside of LED, which may cause the malfunction of LED, the single content of Bromine element is required to be less than 500PPM, the single content of Chlorine element is required to be less than 500PPM, the total content of Bromine element and Chlorine element in the external glue of the application products is required to be less than 1000PPM. Other points for attention, please refer to our LED user manual